

TECHNICAL SPECIFICATION MODEL 620RBL-G2 LOW PROFILE CLAMSHELL

The 620RBL-G2 Low Profile Clamshell is a split-frame pipe lathe for severing and beveling in-line pipe with a range of 14" through 20" nominal diameter with minimal radial and axial clearances.

Accessories

- Model 765RVC Hydraulic Power Supply (for Single or Dual Hydraulic Drive Systems) Available in 480V, 380V, and 240V Configurations.
- Portable Air Filter Caddy (for Single or Dual Air Drive Systems)
- Right Angle Drive Air Motor Kit
- 600RBL OD Tracking Module Kit
- CBM-3 Counterbore Module Kit
- Carbide Sever Accessory Kit
- Heavy Duty Sever Accessory Kit
- Template Tracer Module (TTM)

Special Features

- Easily adjustable preloaded 90° Vee precision bearings stabilize the rotating head to provide long life, low maintenance, stability, and precision.
- The Clamshell splits into two halves for mounting on a closed looped system. All parts are secured to the two halves to avoid loss of parts and provide maximum ease of handling.
- The machine has adjustable mounting pads for out-of-round pipe conditions.
- Dual tool modules, with auto-feed sprockets and adjustable slide ways, ensure operator safety and maximum maintainability with minimum operator training.
- The auto-feed star sprockets provide .0036" (.09mm) of radial feed per revolution for a controlled depth of cut.
- Drive gears and bearing surfaces are covered and sealed to increase operator safety and to prevent damage from chips.
- Operator controls are located away from the rotating head for enhanced operator safety.
- The modular design provides easy maintenance, and maximum versatility for drive and tooling options.
- The system may be configured with pneumatic, hydraulic, or electric drive motors.
- Machine components include high strength aluminum and alloy steel construction with corrosion resistant coatings for maximum robustness and reliability in harsh environments.

Specifications

Reference Drawings follow at end of document.

Pipe Cutting Capacities

Cutting Capacities on 10" through 16" pipe with standard tool modules

- Severing 2.50" (63.5mm) wall
- Severing and single beveling 2.00" (50.8mm) wall
- Severing and double beveling 1.50" (38.1mm) wall

Materials include but are not limited to:

- Carbon steel
- Low alloy steel
- Chrome steel (20% max)
- Chrome/moly alloys (Rc 32 max.)
- Copper nickel alloys
- Austenitic stainless steel
- Inconel
- Copper
- Aluminum

**Some materials and geometries may require special procedures and step-cut operations.*

Clearance and Dimensions

Tooling

A wide variety of high speed steel tool bits are available, including tool bit sizes ranging from 3/8" to 1" wide for maximum machining efficiency. 600RBL-G2 tooling includes:

- High Speed Steel Sever
 - Sever and Right Hand Bevel
 - Sever and Double Bevel
 - Sever and J-prep
 - OD turn
 - Carbide Sever
 - Sever and Left Hand Bevel
 - Sever and Compound Bevel
 - Counterbore
 - Custom Geometries upon request
-

Weight

- Basic machine with 2 drive housings 148 lbs. (67.2 Kg)
 - Standard tool modules 20 lbs. (9.1 Kg)/module
 - Air motors 22 lbs. (9.9 Kg) ea.
 - Hydraulic motors 28 lbs. (12.7 Kg) ea.
 - Electric motors 23 lbs. (10.4 Kg) ea.
-

Drive Motor Options

In-line Air Motor and Optional Right Angle Drive Head

- Single Motor Air requirements 90 PSI (6.3 bar) at 95 CFM (45 l/sec)
- Dual Motor Air requirements 90 PSI (6.3 bar) at 190 CFM (90 l/sec)
- In-line Air Clamshell Max. Speed 21 RPM
- Right Angle Air Clamshell Max. Speed 10 RPM

In-line Hydraulic Motors

- Requires separate hydraulic power supply (see 765RVC technical specifications)
- Clamshell Speed at Max. Flow 34 RPM

In-line Electric Motor with Variable Speed Output

- Power requirements 20A at 110 VAC/60Hz or 10A at 220VAC/50Hz
- Clamshell Speed at Max. Power 30 RPM

Tool Modules

- Working diameter 14" - 20" pipe
- Travel per side 3.00" (76.2mm)
- Feed rate .0036" (.09mm)/rev.

Mounting

4 adjustable mounting pads with 2 additional mounting jackscrews for 14", 16", 18", and 20" pipe.

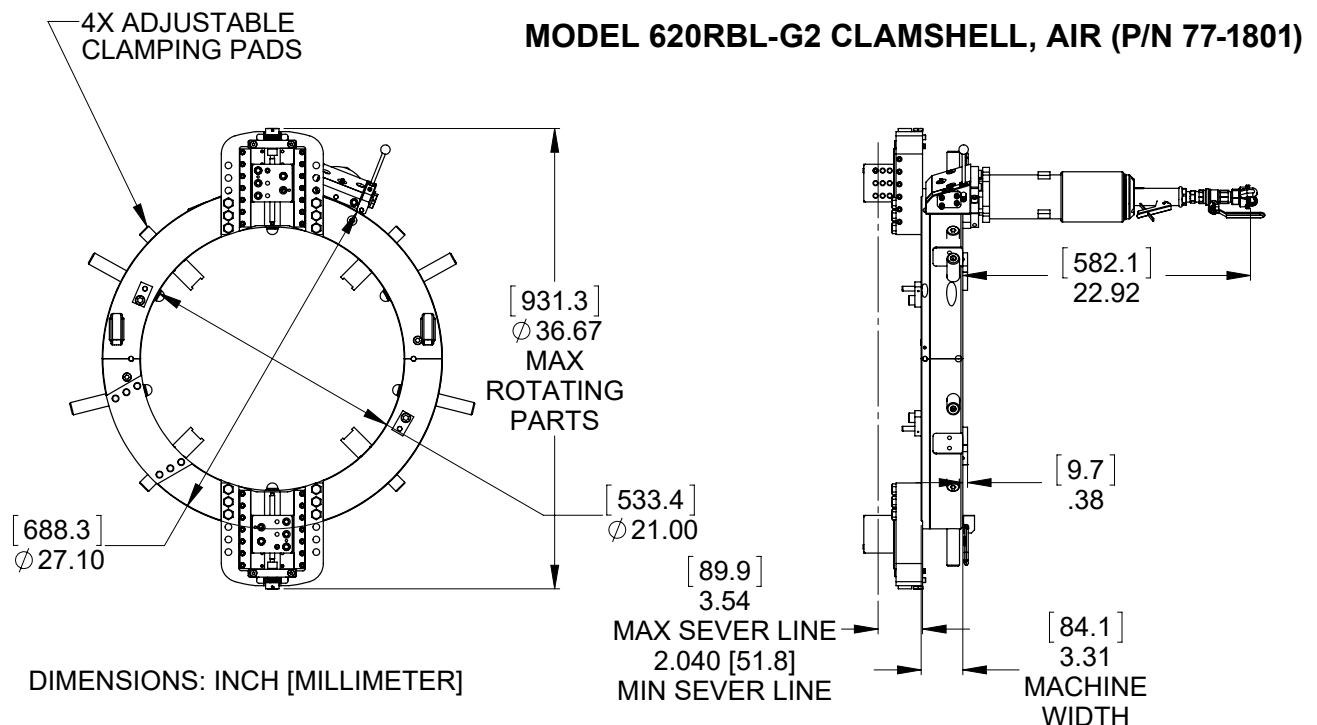

MODEL 620RBL-G2 CLAMSHELL, RA AIR (P/N 77-1802)

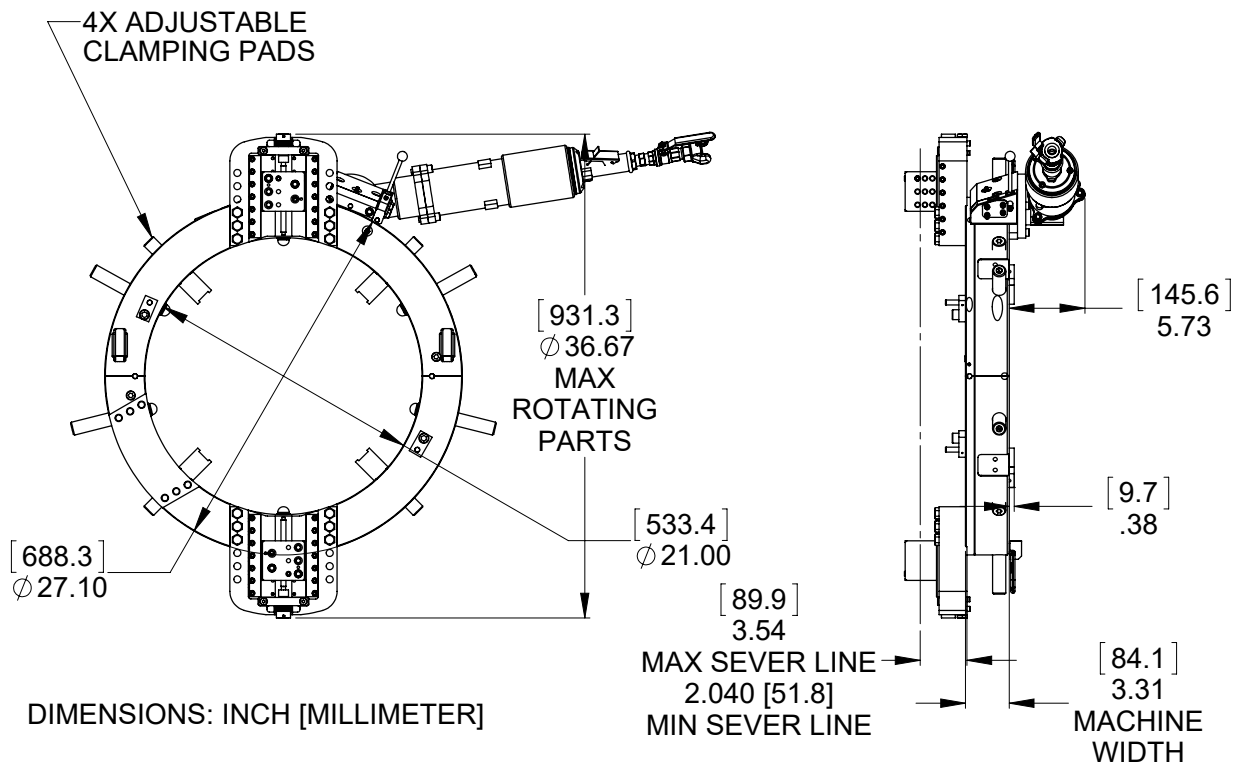

MODEL 620RBL-G2 CLAMSHELL, HYDRAULIC (P/N 77-1803)

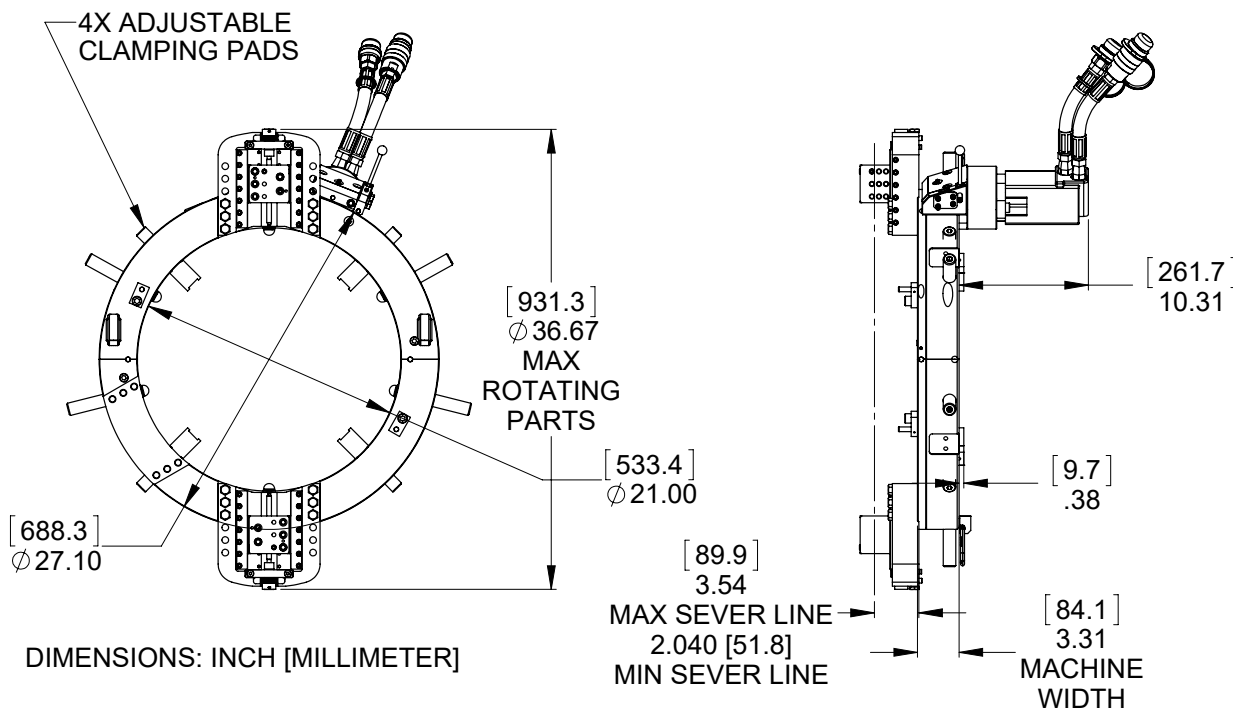

MODEL 620RBL-G2 CLAMSHELL, ELECTRIC (P/N 77-1804)

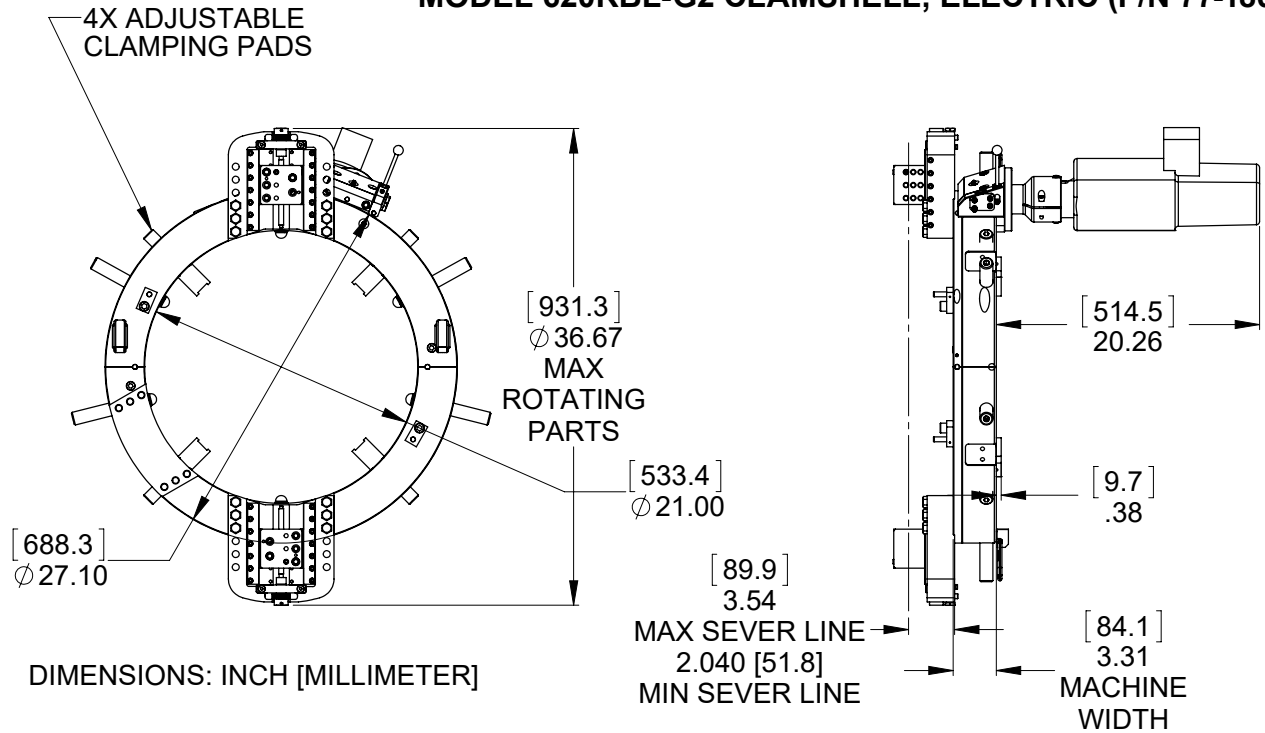

Note To The Customer

Spare Parts and Standard Tool Bits are available from stock. Engineering design services for custom tool bits and special function modifications are available from the factory.

All Tri Tool Technologies and allied equipment products are subject to design improvements and specification changes at any time with no obligation to units already sold.

Warranty (limited): Parts and equipment are warranted against defects in material and workmanship for a period of one (1) year from date of purchase. Full details supplied on request and/or with the tools.

 www.tritool.com

 @tritooltechnologies

 @tritooltech

 @tritooltechnologies



3041 Sunrise Blvd
Rancho Cordova, CA 95742
+916-288-6100
+1-800-345-5015
Fax 916-288-6160

Copyright © Proprietary property of Tri Tool Technologies. No reproduction, use or duplication of the information shown hereon is permitted without the express written consent of Tri Tool Technologies.