



# Orbital cutting

A proper tube preparation is essential to produce a proper weld.

AXXAIR's orbital cutting machines feature stainless steel concentric jaws to prevent the deformation of the tubes, especially the one with thin walls, during clamping.

The perfect position of the tube within the machine also guaranty the perpendicularity of the cut as the saw travels around the tube and the consistency that perpendicularity cut after cut. The precision of our cutting machine allow a

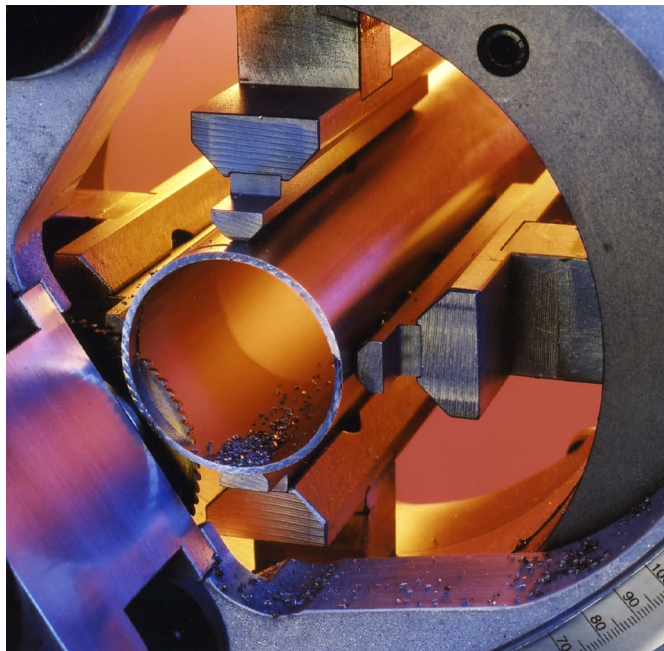

## FLEXIBILITY, PRODUCTIVITY

AXXAIR frames (except CC81, CC121ECO and 171ECO) are easily scalable for beveling and welding use.

## QUALITY, GEOMETRIC PRECISION

Cutting with no tube distortion (multi-contacts concentric clamping) ideal for thin wall stainless steel tubes. Great perpendicularity (<math><0.25\text{ mm}</math>) of the cut and superb surface finish (few burrs).

## PORTABILITY

With the easy to remove sawing attachment, AXXAIR's cutting machines are easy to transport on site or move within a workshop.

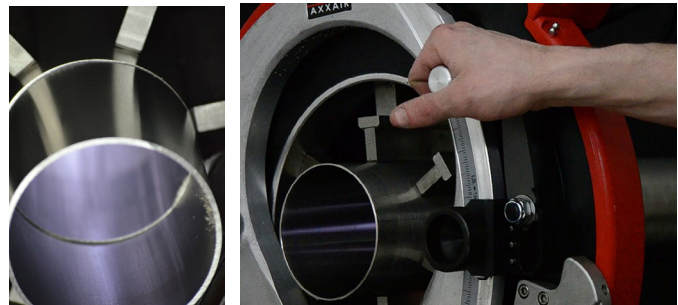

perfect tube to tube alignment with the smallest gap possible, removing the need to facing the tube therefore saving a significant amount of time and money.

AXXAIR's orbital cutting machines are an indispensable tool for any automatic and orbital welding.

AXXAIR offers the **largest orbital cutting range in the world !**

11 different models to cut tubes from diameter 5 to 1100 mm !

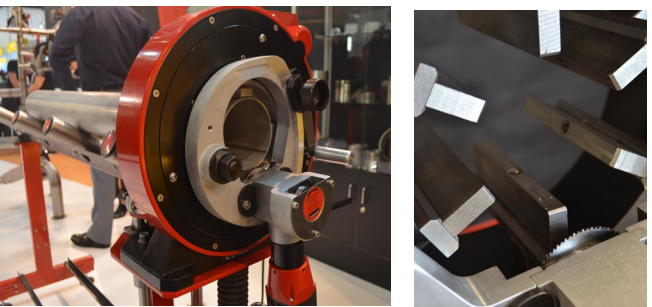
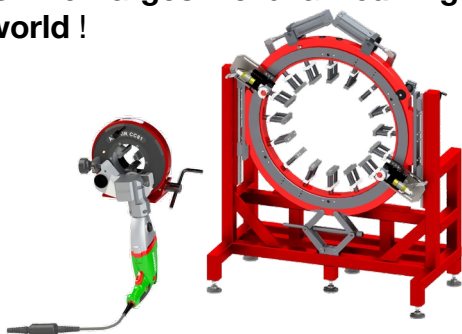

Please do not hesitate to contact us for all enquiries relating to orbital cutting technology.

We are glad to share our decades long experience in orbital cutting and helping you to select the solution that fits your needs.



# The ECO Cutting range

## 81M - 121ECO - 171ECO



For more than 20 years AXXAIR has been developing scalable, flexible and reliable machines featuring our patented concentric clamping design and many other functions.

The frames of our cutting machines 122 - 322 can be fitted with a cutting motor, a bevelling motor or with a TIG welding torch.

Our ECO range differs from this concept and is specialized in cutting thin wall tubes. It offers the same quality of cut than the CC 122 - 322 range in a more affordable package for customers who do not need to bevel or weld with the same machine.

We developed the ECO cutting range in order to respond to these users looking simply for a cutting solution for thin tubes.

**Machines dedicated to thin tubes < 5 mm wall thickness\***

**Easy to move around and lightweight**

**Attractive prices**

AXXAIR choose Metabo to power our ECO range because of the large speed range and higher torque matching the requirements for cutting stainless steel thin wall tubes.

The handle of the Metabo power unit also makes easy and convenient to rotate the blade around the tube.

Our 121 and 171ECO range share the same safe and efficient diameter setting and blade penetration unit than our CC range.

The ECO range comes in a more affordable package but still features most of the designs that made our more advanced CC range so popular among the industry.

Because our ECO range is dedicated to cutting, some of the upgrades and accessories available on the CC range like automatic rotation or automatic clamping are not available for this type of cutting machines.

For more details, accessories and the references please see the following pages of this catalogue.

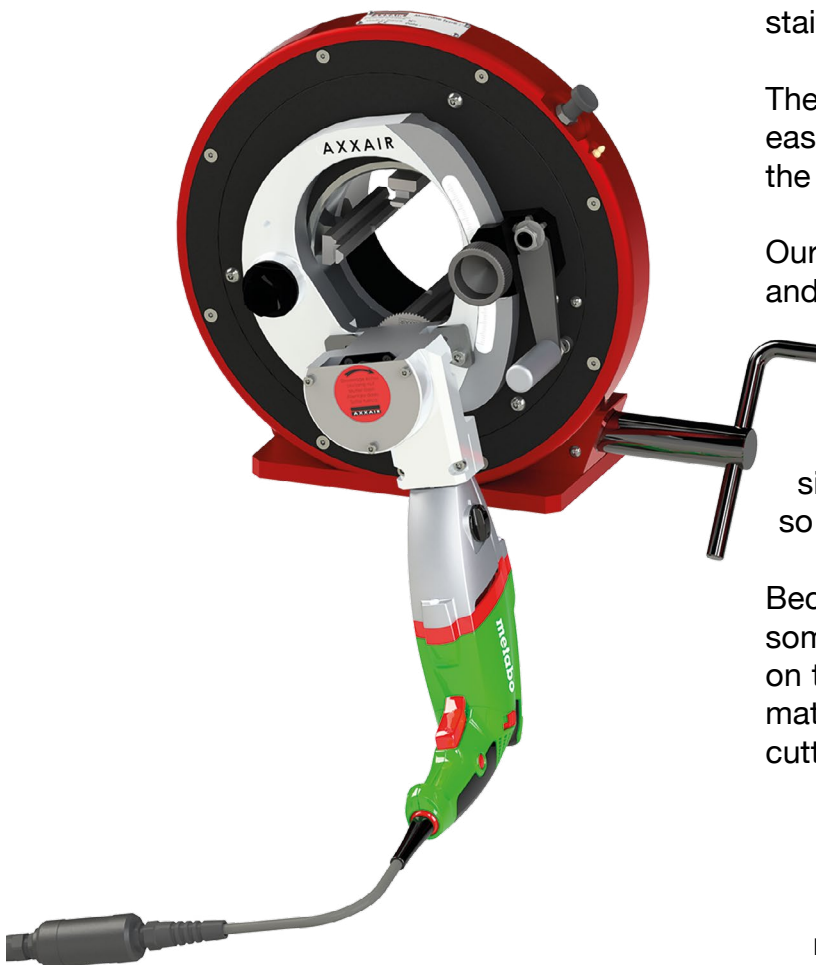

\*depending on the type of steel



# 81M - 121ECO - 171ECO

ORBITAL CUTTING

### No tube deformation

Concentric clamping system



Basic and extra stainless steel jaws: no pollution of stainless steel tubes

### Limited vibration and tube distortion

Optimised blade to jaws distance

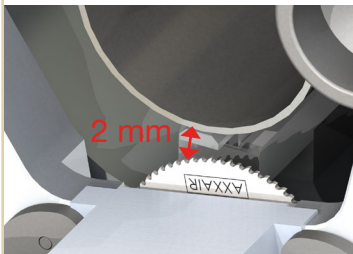

### Easy handling and transportation



### Cutting precision

Perpendicular cuts  
< 0.25 mm



### Operator safety feature

Penetration check feature

### Uptake

121ECO +171ECO: feature a dual blade position allowing to cut elbows or flanges with no wasting of tube.

### Motor 1300W

Speed adjustment through gearbox and electronic variator

### Cutting capacity:

Up to 5 mm wall thickness\*



### Continuous use

Anti-twist cable with bearings. Protects the electric cable from damage resulting from rotation around the tube.

### Opening capacity

81M	ø5 - ø78 mm 0.25 - 3 "
121ECO	ø5 - ø121 mm 0.25 - 4.5 "
171ECO	ø16 - ø170 mm 0.625 - 6.625 "

\*depending on the type of steel

# 81M - 121ECO - 171ECO

## Technical features :

With the Metabo power unit, our ECO range features a large range of blade rotation speed and the right torque for cutting stainless steel thin wall tubes.

### Electric motor 1300W:

- Mechanical gearbox and electric speed variator
- 50/60 HZ
- single-phase motor

Except the 81M, all the machines' cutting motors are shipped in a convenient carrying case together with all necessary tools for operating the machine.

Because of its small form and low weight, the 81M cutting motor and the tools are included in the machine's transport case.

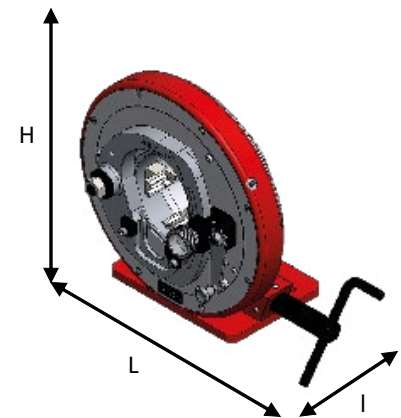
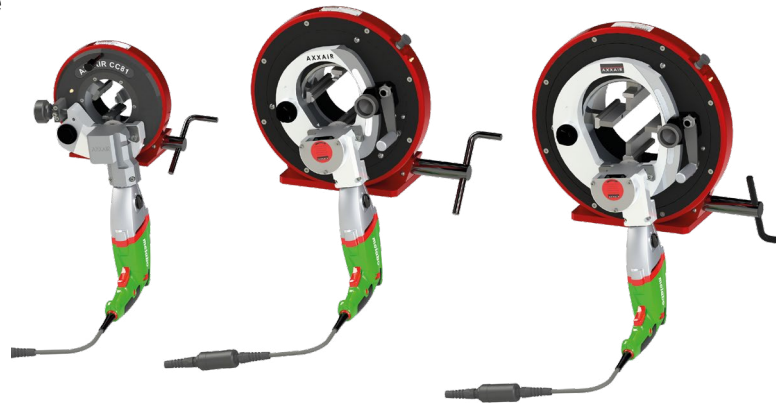

	Product Code	Machine's jaw opening capacity in mm		Net weight	Dimensions (HxLxw in mm)
		With basic jaws	With extra jaws (included)		
120V 1300W	81M11	Ø5 - Ø78	-	15 kg	263 x 346 x 236
	121ECO1	Ø24 - Ø121	Ø5 - Ø108	38 kg	432 x 520 x 297
	171ECO1	Ø70 - Ø170	Ø16 - Ø118	44 kg	453 x 550 x 307
230V 1300W	81M21	Ø5 - Ø78	-	15 kg	263 x 346 x 236
	121ECO2	Ø24 - Ø121	Ø5 - Ø108	38 kg	432 x 520 x 297
	171ECO2	Ø70 - Ø170	Ø16 - Ø118	44 kg	453 x 550 x 307